

# Monolithic Linear Lithium-Ion Battery Charger with Thermal Regulation

## FEATURES

- Complete Linear Charger for 1-Cell Lithium-Ion Batteries
- Thermal Regulation Maximizes Charging Rate without Risk of Overheating\*
- No External MOSFET, Sense Resistor or Blocking Diode Required
- Up to 1.5A Charge Current
- Preset Charge Voltage with 1% Accuracy
- Programmable Charge Current with 7% Accuracy
- Programmable Charge Termination Timer
- Tiny Thermally Enhanced 10-Pin MSOP Package
- Charge Current Monitor Useful for Gas Gauging\*
- C/10 Charge Current Detection Output
- Automatic Recharge
- Thermistor Input for Temperature Qualified Charging
- AC Present Logic Output
- 4.1V/4.2V Pin Selectable Output Voltage

## APPLICATIONS

- Cellular Telephones
- Handheld Computers
- Digital Still Cameras
- Charging Docks and Cradles

## DESCRIPTION

The LTC<sup>®</sup>1733 is a standalone constant-current/constant-voltage linear charger for lithium-ion batteries with an on-chip power MOSFET. Internal thermal feedback regulates the charge current to limit die temperature during high power operation or high ambient temperature conditions. This feature allows the user to program a high charge current without risk of damaging the LTC1733 or the handheld product.

No external current sense resistor is needed and no blocking diode is required due to the internal MOSFET architecture. The charge current and charge time can be set externally with a single resistor and capacitor, respectively. When the input supply (wall adapter) is removed, the LTC1733 automatically enters a low current sleep mode, dropping the battery drain current to less than 5 $\mu$ A.

The LTC1733 also includes NTC temperature sensing, C/10 detection circuitry, AC present logic, 4.1V/4.2V pin selectability and low battery charge conditioning (trickle charging).

The LTC1733 is available in a 10-pin thermally enhanced MSOP package.

LT, LTC and LT are registered trademarks of Linear Technology Corporation.  
\* Patent Pending

## TYPICAL APPLICATION

Standalone Li-Ion Battery Charger

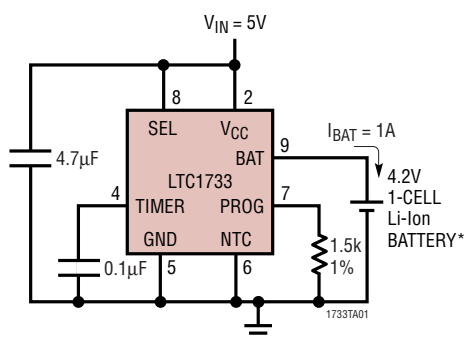

\*AN OUTPUT CAPACITOR MAY BE REQUIRED  
DEPENDING ON BATTERY LEAD LENGTH

Charge Current vs Battery Voltage

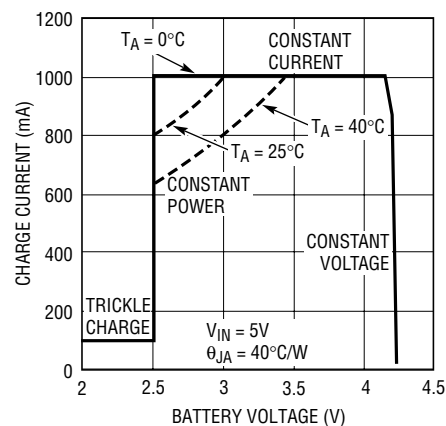

1733 TA01b  
sn1733 1733fs

**ABSOLUTE MAXIMUM RATINGS**

(Note 1)

Input Supply Voltage ( $V_{CC}$ )	7V
BAT	7V
NTC, SEL, TIMER, PROG	-0.3V to $V_{CC} + 0.3V$
CHRG, FAULT, ACPR	-0.3V to 7V
BAT Short-Circuit Duration	Continuous
BAT Current (Note 2)	1.6A
PROG Current (Note 2)	1.6mA
Junction Temperature	125°C
Operating Temperature Range (Note 3)	-40°C to 85°C
Storage Temperature Range	-65°C to 150°C
Lead Temperature (Soldering, 10 sec)	300°C

**PACKAGE/ORDER INFORMATION**

<p>MSE EXPOSED PAD PACKAGE 10-LEAD PLASTIC MSOP</p> <p><math>T_{JMAX} = 125^{\circ}C</math>, <math>\theta_{JA} = 40^{\circ}C/W</math> (Note 4) EXPOSED PAD IS GROUND. (MUST BE SOLDERED TO PCB FOR MAXIMUM HEAT TRANSFER).</p>	ORDER PART NUMBER
	LTC1733EMSE
	MSE PART MARKING
	LTLX

Consult LTC Marketing for parts specified with wider operating temperature ranges.

**ELECTRICAL CHARACTERISTICS** The ● denotes the specifications which apply over the full operating temperature range, otherwise specifications are at  $T_A = 25^{\circ}C$ ,  $V_{CC} = 5V$

SYMBOL	PARAMETER	CONDITIONS	MIN	TYP	MAX	UNITS
$V_{CC}$	$V_{CC}$ Supply Voltage		● 4.5		6.5	V
$I_{CC}$	$V_{CC}$ Supply Current	Charger On; Current Mode; $R_{PROG} = 30k$ (Note 5) Shutdown Mode; $V_{PROG} = 3V$	●	1 0.9	3 2	mA mA
$V_{BAT}$	$V_{BAT}$ Regulated Output Voltage	SEL = 0V SEL = $V_{CC}$	● 4.059 ● 4.158	4.1 4.2	4.141 4.242	V V
$I_{BAT}$	Battery Pin Current	$R_{PROG} = 3k$ ; Current Mode $R_{PROG} = 1k$ ; Current Mode Shutdown Mode; $V_{PROG} = 3V$ Sleep Mode $V_{CC} < V_{BAT}$ or $V_{CC} < (V_{UV} - \Delta V_{UV})$	● 465 1.395	500 1.5	535 1.605	mA A $\mu A$ $\mu A$
$I_{TRIKL}$	Trickle Charge Current	$V_{BAT} < 2V$ ; $R_{PROG} = 3k$	● 35	50	65	mA
$V_{TRIKL}$	Trickle Charge Trip Threshold	$V_{BAT}$ Rising		2.48		V
$\Delta V_{TRIKL}$	Trickle Charge Trip Hysteresis			100		mV
$V_{UV}$	$V_{CC}$ Undervoltage Lockout Voltage	$V_{CC}$ Rising	●	4.2	4.5	V
$\Delta V_{UV}$	$V_{CC}$ Undervoltage Lockout Hysteresis			150		mV
$V_{MSD}$	Manual Shutdown Threshold Voltage	PROG Pin Voltage Rising		2.15		V
$V_{MSD-HYS}$	Manual Shutdown Hysteresis Voltage			100		mV
$V_{ASD}$	Automatic Shutdown Threshold Voltage	$(V_{CC} - V_{BAT})$ Voltage Falling $(V_{CC} - V_{BAT})$ Voltage Rising		30 60		mV mV

## ELECTRICAL CHARACTERISTICS $T_A = 25^\circ\text{C}$ . $V_{CC} = 5\text{V}$ unless otherwise noted.

SYMBOL	PARAMETER	CONDITIONS	MIN	TYP	MAX	UNITS
$V_{\text{PROG}}$	PROG Pin Voltage	$R_{\text{PROG}} = 3\text{k}$ , $I_{\text{PROG}} = 500\mu\text{A}$ ; Current Mode		1.5		V
$I_{\text{CHRG}}$	$\overline{\text{CHRG}}$ Pin Weak Pulldown Current	$V_{\text{CHRG}} = 1\text{V}$		25		$\mu\text{A}$
$V_{\text{CHRG}}$	$\overline{\text{CHRG}}$ Pin Output Low Voltage	$I_{\text{CHRG}} = 5\text{mA}$		0.35		V
$V_{\text{ACPR}}$	$\overline{\text{ACPR}}$ Pin Output Low Voltage	$I_{\text{ACPR}} = 5\text{mA}$		0.35		V
$V_{\text{FAULT}}$	$\overline{\text{FAULT}}$ Pin Output Low Voltage	$I_{\text{FAULT}} = 5\text{mA}$		0.35		V
$I_{\text{C}/10}$	End of Charge Indication Current Level	$R_{\text{PROG}} = 3\text{k}$	35	50	65	mA
$t_{\text{TIMER}}$	TIMER Accuracy	$C_{\text{TIMER}} = 0.1\mu\text{F}$		$\pm 10$		%
$V_{\text{RECHRG}}$	Recharge Battery Voltage Threshold	Battery Voltage Falling, SEL = 0V Battery Voltage Falling, SEL = 5V		3.9 4.0		V V
$V_{\text{NTC-HOT}}$	NTC Pin Hot Threshold Voltage	$V_{\text{NTC}}$ Falling		2.5		V
$V_{\text{HOT-HYS}}$	NTC Pin Hot Hysteresis Voltage			70		mV
$V_{\text{NTC-COLD}}$	NTC Pin Cold Threshold Voltage	$V_{\text{NTC}}$ Rising		4.375		V
$V_{\text{COLD-HYS}}$	NTC Pin Cold Hysteresis Voltage			70		mV
$V_{\text{NTC-DIS}}$	NTC Pin Disable Threshold Voltage	$V_{\text{NTC}}$ Rising		100		mV
$V_{\text{DIS-HYS}}$	NTC Pin Disable Hysteresis Voltage			10		mV
$V_{\text{SEL-IL}}$	SEL Pin Threshold Input Low		0.3			V
$V_{\text{SEL-IH}}$	SEL Pin Threshold Input High				1	V
$T_{\text{LIM}}$	Junction Temperature in Constant-Temperature Mode			105		$^\circ\text{C}$
$R_{\text{ON}}$	Power MOSFET "ON" Resistance			375		$\text{m}\Omega$

**Note 1:** Absolute Maximum Ratings are those values beyond which the life of a device may be impaired.

**Note 2:** The Absolute Maximum BAT Current Rating of 1.6A is guaranteed by design and current density calculations. The Absolute Maximum PROG Current Rating is guaranteed to be 1/1000 of BAT current rating by design.

**Note 3:** The LTC1733E is guaranteed to meet performance specifications from  $0^\circ\text{C}$  to  $70^\circ\text{C}$ . Specifications over the  $-40^\circ\text{C}$  to  $85^\circ\text{C}$  operating

temperature range are assured by design, characterization and correlation with statistical process controls.

**Note 4:** Failure to solder the exposed backside of the package to the PC board will result in a thermal resistance much higher than  $40^\circ\text{C}/\text{W}$ .

**Note 5:** Supply current includes PROG pin current but does not include any current delivered to the battery through the BAT pin.

**SKYTECH**  
ELECTRONIC

TYPICAL PERFORMANCE CHARACTERISTICS

Battery Regulation Voltage vs Battery Charge Current

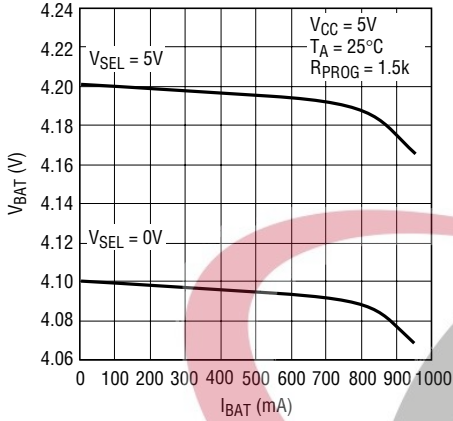

1733 G01

Battery Regulation Voltage vs Temperature

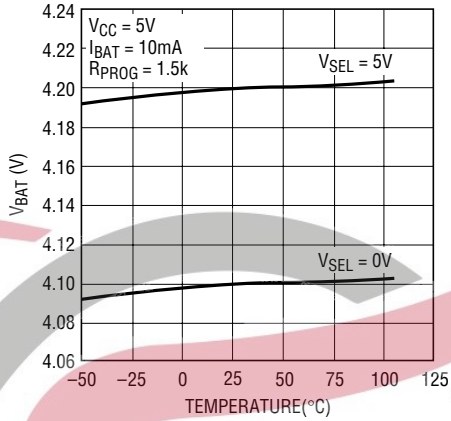

1733 G02

Battery Regulation Voltage vs V<sub>CC</sub>

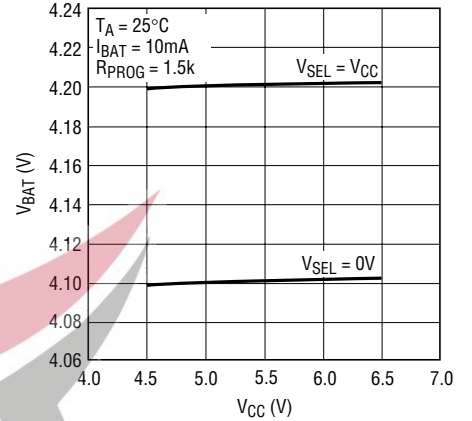

1733 G03

PROG Pin Voltage vs Charge Current

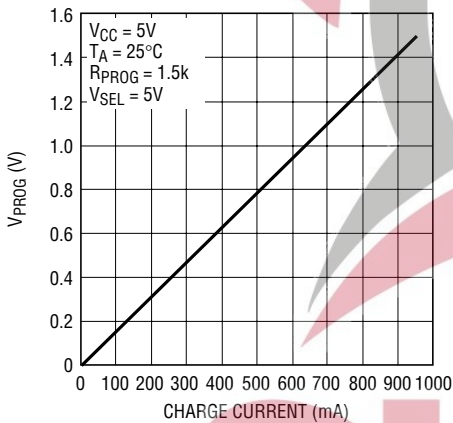

1733 G04

Charge Current vs Battery Voltage

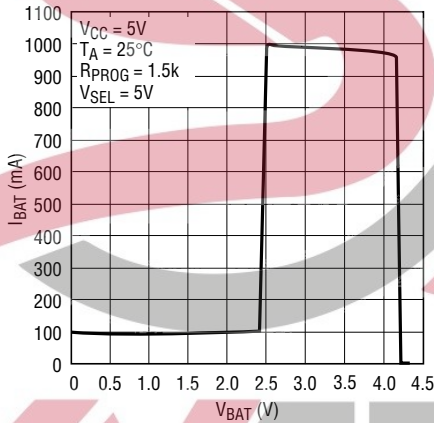

1733 G05

Charge Current vs Input Voltage

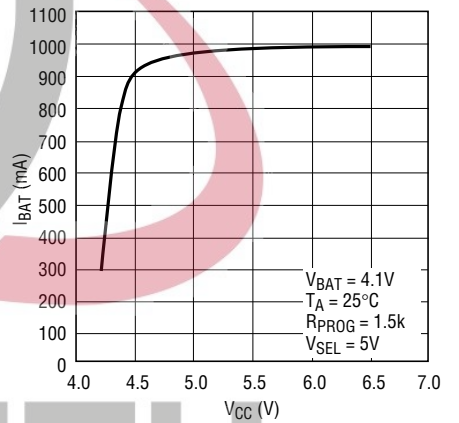

1733 G06

Charge Current vs V<sub>CC</sub>

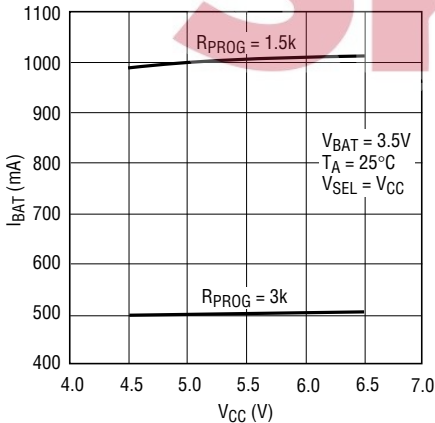

1733 G07

Charge Current vs Temperature with Thermal Regulation

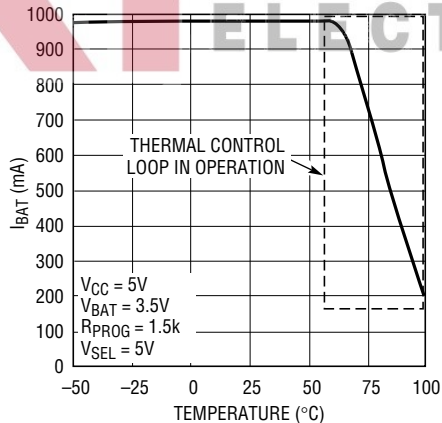

1733 G08

Charge Current vs Temperature

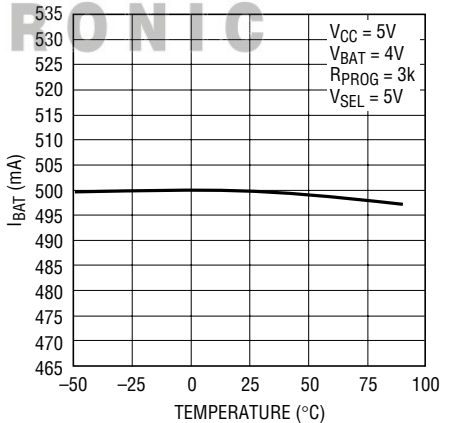

1733 G09

# TYPICAL PERFORMANCE CHARACTERISTICS

**PROG Pin Voltage vs  $V_{CC}$   
Constant Current Mode**

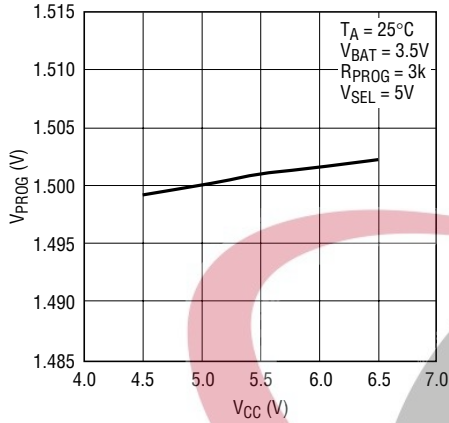

1733 G10

**PROG Pin Voltage vs Temperature  
Constant Current Mode**

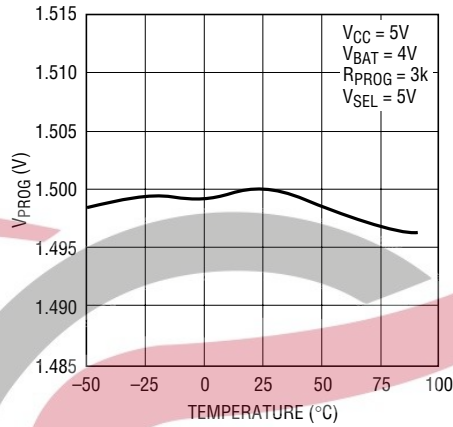

1733 G11

**Trickle Charge Current vs  
Temperature**

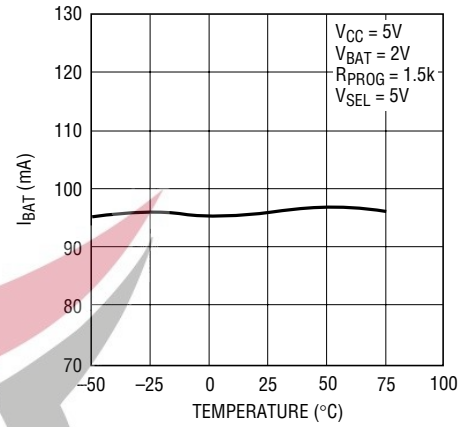

1733 G12

**Trickle Charge Current vs  $V_{CC}$**

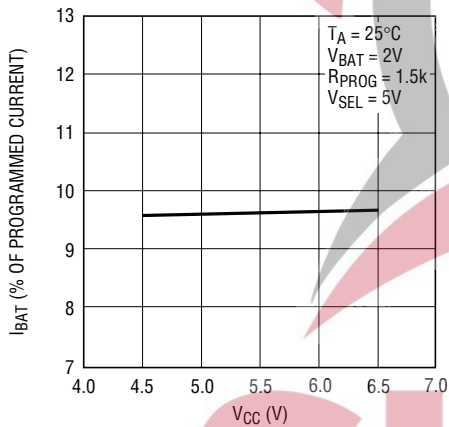

1733 G13

**Timer Accuracy vs Temperature**

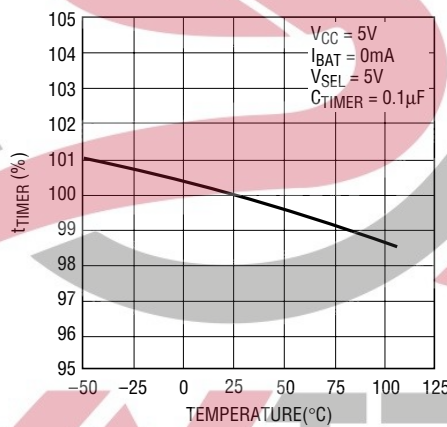

1733 G14

**Timer Accuracy vs  $V_{CC}$**

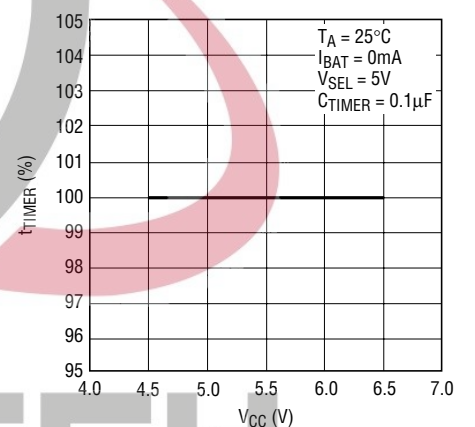

1733 G15

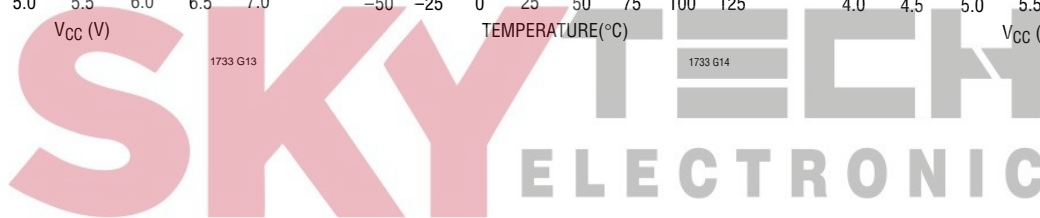

## PIN FUNCTIONS

**CHRG:** Open-Drain Charge Status Output. When the battery is being charged, the  $\overline{\text{CHRG}}$  pin is pulled low by an internal N-channel MOSFET. When the charge current drops to 10% of the full-scale current, the N-channel MOSFET latches off and a 25 $\mu\text{A}$  current source is connected from the CHRG pin to ground. The C/10 latch can be cleared by momentarily pulling the PROG pin above the 2.15V shutdown threshold, or by toggling  $V_{\text{CC}}$ . When the timer runs out or the input supply is removed, the current source is disconnected and the CHRG pin is forced to a high impedance state.

**$V_{\text{CC}}$ :** Positive Input Supply Voltage. When  $V_{\text{CC}}$  is within 30mV of  $V_{\text{BAT}}$  or less than the undervoltage lockout threshold, the LTC1733 enters sleep mode, dropping  $I_{\text{BAT}}$  to less than 5 $\mu\text{A}$ .  $V_{\text{CC}}$  can range from 4.5V to 6.5V. Bypass this pin with at least a 4.7 $\mu\text{F}$  ceramic capacitor to ground.

**$\overline{\text{FAULT}}$ :** Open-Drain Fault Status Output. The  $\overline{\text{FAULT}}$  open-drain logic signal indicates that the charger has timed out under trickle charge conditions (1/4 of total time period) or the NTC comparator is indicating an out-of-range battery temperature condition. When  $V_{\text{BAT}}$  is less than 2.48V, trickle charging activates whereby the charge current drops to one tenth of its programmed value and the timer period is reduced by a factor of four. When one fourth of the timing period has elapsed, if  $V_{\text{BAT}}$  is still less than 2.48V, trickle charging stops and the  $\overline{\text{FAULT}}$  pin latches to ground. The fault can be cleared by toggling  $V_{\text{CC}}$ , momentarily pulling the PROG pin above the 2.15V shutdown threshold, or pulling the BAT pin above 2.48V. If the NTC comparator is indicating an out-of-range battery temperature condition, then the  $\overline{\text{FAULT}}$  pin will pull to ground until the temperature returns to the acceptable range.

**TIMER:** Timer Capacitor. The timer period is set by placing a capacitor,  $C_{\text{TIMER}}$ , to ground. The timer period is:

$$\text{Time (Hours)} = (C_{\text{TIMER}} \cdot 3 \text{ hr}) / (0.1 \mu\text{F})$$

Short the TIMER pin to ground to disable the internal timer function.

**GND:** Ground. Connect exposed back package to ground.

**NTC:** Input to the NTC (Negative Temperature Coefficient) Thermistor Temperature Monitoring Circuit. With an external 10k $\Omega$  NTC thermistor to ground and a 1% resistor to  $V_{\text{CC}}$ , this pin can sense the temperature of the battery pack and stop charging when it is out of range. When the voltage at this pin drops below  $(0.5) \cdot (V_{\text{CC}})$  at hot temperatures or rises above  $(0.875) \cdot (V_{\text{CC}})$  at cold, charging is suspended and the internal timer is frozen. The  $\overline{\text{CHRG}}$  pin output status is not affected in this hold state. The  $\overline{\text{FAULT}}$  pin is pulled to ground, but not latched. When the temperature returns to an acceptable range, charging will resume and the  $\overline{\text{FAULT}}$  pin is released. The NTC feature can be disabled by grounding the NTC pin.

**PROG:** Charge Current Program, Shutdown Input and Charge Current Monitor Pin. The charge current is programmed by connecting a resistor,  $R_{\text{PROG}}$  to ground. When in constant-current mode, the LTC1733 servos the PROG pin voltage to 1.5V. In all modes the voltage on the PROG pin can be used to measure the charge current as follows:

$$I_{\text{CHG}} = (V_{\text{PROG}} / R_{\text{PROG}}) \cdot 1000.$$

The IC can be forced into shutdown by pulling the PROG pin above the 2.15V shutdown threshold voltage (note: it will not be pulled up when allowed to float).

**SEL:** 4.1V/4.2V Battery Selection Input. Grounding this pin sets the battery float voltage to 4.1V, while connecting to  $V_{\text{CC}}$  sets the voltage to 4.2V.

**BAT:** Charge Current Output. A bypass capacitor of at least 1 $\mu\text{F}$  with a 1 $\Omega$  series resistor is required to minimize ripple voltage when the battery is not present. A precision internal resistor divider sets the final float potential on this pin. The internal resistor divider is disconnected in sleep and shutdown modes.

**$\overline{\text{ACPR}}$ :** Open-Drain Power Supply Status Output. When  $V_{\text{CC}}$  is greater than the undervoltage lockout threshold and at least 30mV above  $V_{\text{BAT}}$ , the  $\overline{\text{ACPR}}$  pin will pull to ground. Otherwise, the pin is forced to a high impedance state.

**SIMPLIFIED BLOCK DIAGRAM**

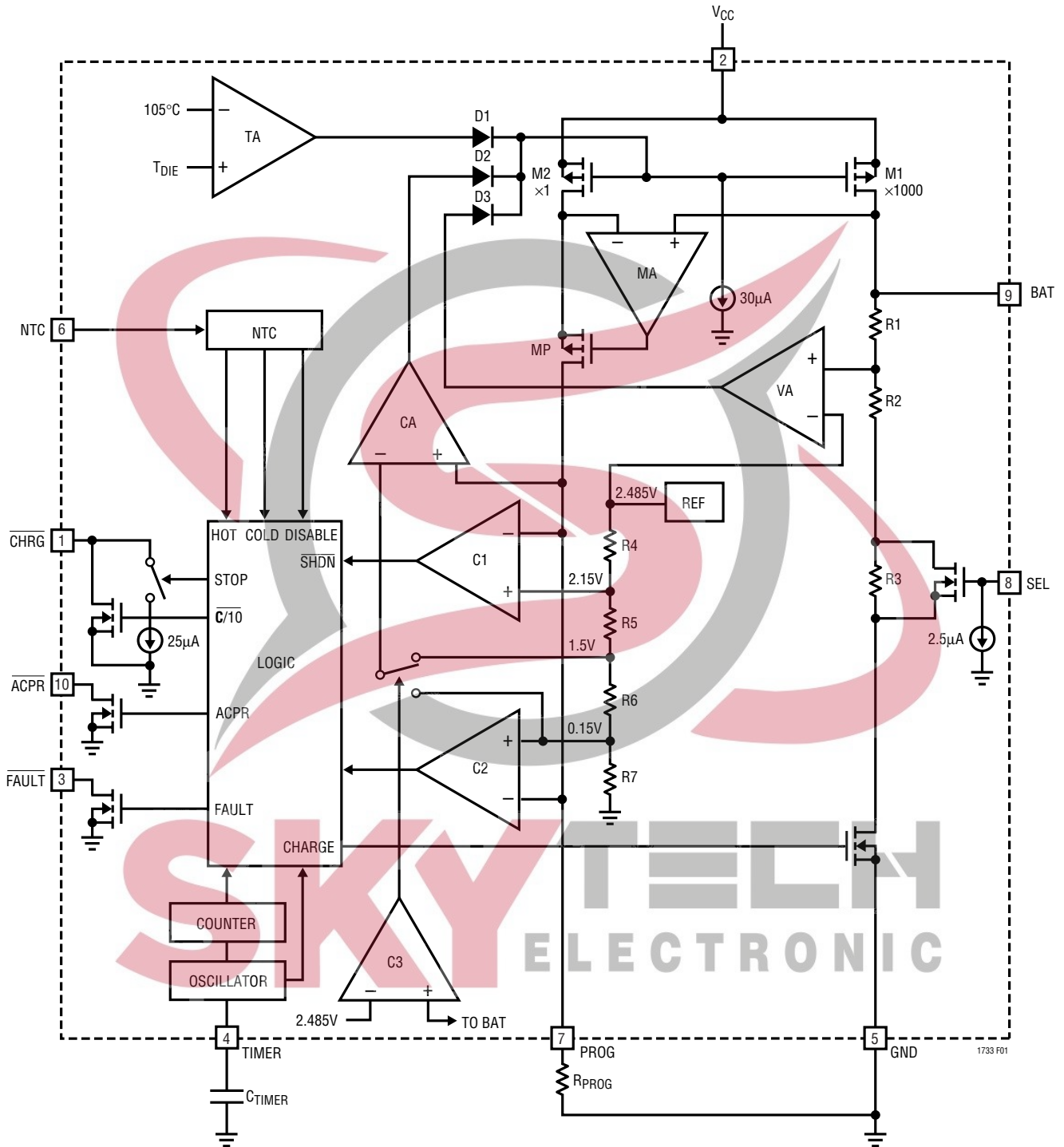

Figure 1.

## OPERATION

The LTC1733 is a linear battery charger designed primarily for charging single cell lithium-ion batteries. Featuring an internal P-channel power MOSFET, the charger uses a constant-current/constant-voltage charge algorithm with programmable current and a programmable timer for charge termination. Charge current can be programmed up to 1.5A with a final float voltage accuracy of  $\pm 1\%$ . No blocking diode or sense resistor is required thus dropping the external component count to three for the basic charger circuit. The  $\overline{\text{CHRG}}$ ,  $\overline{\text{ACPR}}$ , and  $\overline{\text{FAULT}}$  open-drain status outputs provide information regarding the status of the LTC1733 at all times. An NTC thermistor input provides the option of charge qualification using battery temperature.

An internal thermal limit reduces the programmed charge current if the die temperature attempts to rise above a preset value of approximately  $105^{\circ}\text{C}$ . This feature protects the LTC1733 from excessive temperature, and allows the user to push the limits of the power handling capability of a given circuit board without risk of damaging the LTC1733 or the external components. Another benefit of the LTC1733 thermal limit is that charge current can be set according to typical, not worst-case, ambient temperatures for a given application with the assurance that the charger will automatically reduce the current in worst-case conditions.

The charge cycle begins when the voltage at the  $V_{\text{CC}}$  pin rises above the UVLO level and a program resistor is connected from the PROG pin to ground. At the beginning of the charge cycle, if the battery voltage is below 2.48V, the charger goes into trickle charge mode to bring the cell voltage up to a safe level for charging. The charger goes

into the fast charge constant-current mode once the voltage on the BAT pin rises above 2.48V. In constant-current mode, the charge current is set by  $R_{\text{PROG}}$ .

When the battery approaches the final float voltage, the charge current begins to decrease as the LTC1733 switches to constant-voltage mode. When the current drops to 10% of the full-scale charge current, an internal comparator latches off the MOSFET at the  $\overline{\text{CHRG}}$  pin and connects a weak current source to ground to indicate a near end-of-charge (C/10) condition. The C/10 latch can be cleared by momentarily pulling the PROG pin above the 2.15V shutdown threshold, or momentarily removing and reapplying  $V_{\text{CC}}$ .

An external capacitor on the TIMER pin sets the total charge time. When this time elapses the charge cycle terminates and the  $\overline{\text{CHRG}}$  pin assumes a high impedance state. To restart the charge cycle, simply remove the input voltage and reapply it, or force the PROG pin above the 2.15V shutdown threshold (note: simply floating the PROG pin will not restart the charging cycle).

For lithium-ion and similar batteries that require accurate final float potential, the internal reference, voltage amplifier and the resistor divider provide regulation with  $\pm 1\%$  (max) accuracy.

When the input voltage is not present, the charger goes into a sleep mode, dropping battery drain current,  $I_{\text{BAT}}$ , to less than  $5\mu\text{A}$ . This greatly reduces the current drain on the battery and increases the standby time. The charger can be shut down ( $I_{\text{CC}} = 0.9\text{mA}$ ) by forcing the PROG pin above 2.15V.



## APPLICATIONS INFORMATION

### Undervoltage Lockout (UVLO)

An internal undervoltage lockout circuit monitors the input voltage and keeps the charger in shutdown mode until  $V_{CC}$  rises above the undervoltage lockout threshold. The UVLO circuit has a built-in hysteresis of 150mV. Furthermore, to protect against reverse current in the power MOSFET, the UVLO circuit keeps the charger in shutdown mode if  $V_{CC}$  falls to within 30mV of the battery voltage. If the UVLO comparator is tripped, the charger will not come out of shutdown until  $V_{CC}$  rises 60mV above the battery voltage.

### Trickle Charge and Defective Battery Detection

At the beginning of a charge cycle, if the battery voltage is low (below 2.48V) the charger goes into trickle charge reducing the charge current to 10% of the full-scale current. If the low battery voltage persists for one quarter of the total charge time, the battery is assumed to be defective, the charge cycle is terminated, the  $\overline{\text{CHRG}}$  pin output assumes a high impedance state, and the  $\overline{\text{FAULT}}$  pin latches low. The fault can be cleared by toggling  $V_{CC}$ , temporarily forcing the PROG pin above 2.15V, or temporarily forcing the BAT pin voltage above 2.48V.

### Shutdown

The LTC1733 can be shutdown ( $I_{CC} = 0.9\text{mA}$ ) by pulling the PROG pin above the 2.15V shutdown threshold voltage. In shutdown the internal linear regulator is turned off, and the internal timer is reset.

### Recharge

The LTC1733 has the ability to recharge a battery assuming that the battery voltage has been charged above 4.05V (SEL = 5V) or 3.95V (SEL = 0V). Once above these thresholds, a new charge cycle will begin if the battery voltage drops below 4V (SEL = 5V) or 3.9V (SEL = 0V) due to either a load on the battery or self-discharge. The recharge circuit integrates the BAT pin voltage for a few milliseconds to prevent a transient from restarting the charge cycle.

If the battery voltage remains below 2.48V during trickle charge for 1/4 of the programmed time, the battery may be defective and the charge cycle will end. In addition, the

recharge comparator is disabled and a new charge cycle will not begin unless the input voltage is toggled, the PROG pin is pulled above the 2.15V shutdown threshold, or the BAT pin is pulled above the 2.48V trickle charge threshold.

### Programming Charge Current

The formula for the battery charge current (see Figure 1) is:

$$I_{\text{CHG}} = (I_{\text{PROG}}) \cdot 1000 \\ = (1.5\text{V} / R_{\text{PROG}}) \cdot 1000 \text{ or}$$

$$R_{\text{PROG}} = 1500 / I_{\text{CHG}}$$

where  $R_{\text{PROG}}$  is the total resistance from the PROG pin to ground. Under trickle charge conditions, this current is reduced to 10% of the full-scale value.

For example, if 500mA charge current is required, calculate:

$$R_{\text{PROG}} = 1500 / 0.5\text{A} = 3\text{k}\Omega$$

For best stability over temperature and time, 1% metal-film resistors are recommended.

If the charger is in constant-temperature or constant-voltage mode, the battery current can be monitored by measuring the PROG pin voltage as follows:

$$I_{\text{CHG}} = (V_{\text{PROG}} / R_{\text{PROG}}) \cdot 1000$$

### Programming the Timer

The programmable timer is used to terminate the charge cycle. The timer duration is programmed by an external capacitor at the TIMER pin. The total charge time is:

$$\text{Time (Hours)} = (3 \text{ Hours}) \cdot (C_{\text{TIMER}} / 0.1\mu\text{F}) \text{ or}$$

$$C_{\text{TIMER}} = 0.1\mu\text{F} \cdot \text{Time (Hours)} / 3 \text{ (Hours)}$$

The timer starts when an input voltage greater than the undervoltage lockout threshold level is applied and the program resistor is connected to ground. After a time-out occurs, the charge current stops, and the  $\overline{\text{CHRG}}$  output assumes a high impedance state to indicate that the charging has stopped. Connecting the TIMER pin to ground disables the timer function.

## APPLICATIONS INFORMATION

### Open-Drain Status Outputs

The LTC1733 has three open-drain status outputs:  $\overline{\text{ACPR}}$ ,  $\overline{\text{CHRG}}$  and  $\overline{\text{FAULT}}$ . The  $\overline{\text{ACPR}}$  pin pulls low when an input voltage greater than the undervoltage lockout threshold is applied and goes high impedance when power ( $V_{\text{IN}} < V_{\text{UV}}$ ) is removed.  $\overline{\text{CHRG}}$  and  $\overline{\text{FAULT}}$  work together to indicate the status of the charge cycle. Table 1 describes the status of the charge cycle based on the  $\overline{\text{CHRG}}$  and  $\overline{\text{FAULT}}$  outputs.

Table 1.

$\overline{\text{FAULT}}$	$\overline{\text{CHRG}}$	Description
High	Low	Charge cycle has started, C/10 has not been reached and charging is proceeding normally.
Low	Low	Charge cycle has started, C/10 has not been reached, but the charge current and timer have been paused due to an NTC out-of-temperature condition.
High	25 $\mu\text{A}$ pulldown	C/10 has been reached and charging is proceeding normally.
Low	25 $\mu\text{A}$ pulldown	C/10 has been reached but the charge current and timer have paused due to an NTC out-of-temperature condition.
High	High	Normal timeout (charging has terminated).
Low	High	If $\overline{\text{FAULT}}$ goes low and $\overline{\text{CHRG}}$ goes high impedance simultaneously, then the LTC1733 has timed out due to a bad cell ( $V_{\text{BAT}} < 2.48\text{V}$ after one-quarter the programmed charge time). If $\overline{\text{CHRG}}$ goes high impedance first, then the LTC1733 has timed out normally (charging has terminated), but NTC is indicating an out-of-temperature condition.

### $\overline{\text{CHRG}}$ Status Output Pin

When the charge cycle starts, the  $\overline{\text{CHRG}}$  pin is pulled to ground by an internal N-channel MOSFET capable of driving an LED. When the charge current drops to 10% of the full-scale current (C/10), the N-channel MOSFET is latched off and a weak 25 $\mu\text{A}$  current source to ground is connected to the  $\overline{\text{CHRG}}$  pin. After a time-out occurs, the pin assumes a high impedance state. By using two different value pull-up resistors a microprocessor can detect three states from this pin (charging, C/10, and time-out). See Figure 2.

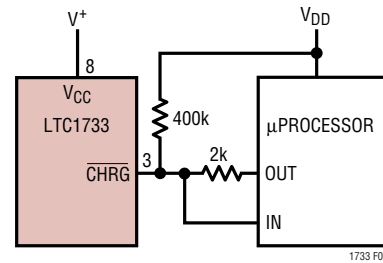

Figure 2. Microprocessor Interface

When the LTC1733 is in charge mode, the  $\overline{\text{CHRG}}$  pin is pulled low by the internal N-channel MOSFET. To detect this mode, force the digital output pin, OUT, high and measure the voltage at the  $\overline{\text{CHRG}}$  pin. The N-channel MOSFET will pull the pin low even with the 2k pull-up resistor. Once the charge current drops to 10% of the full-scale current (C/10), the N-channel MOSFET is turned off and a 25 $\mu\text{A}$  current source is connected to the  $\overline{\text{CHRG}}$  pin. The IN pin will then be pulled high by the 2k pull-up. By forcing the OUT pin to a high impedance state, the current source will pull the pin low through the 400k resistor. When the internal timer has expired, the  $\overline{\text{CHRG}}$  pin will assume a high impedance state and the 400k resistor will then pull the pin high to indicate that charging has terminated.

### NTC Thermistor

The battery temperature is measured by placing a negative temperature coefficient (NTC) thermistor close to the battery pack. The NTC circuitry is shown in Figure 3. To use this feature, connect a 10k NTC thermistor between the NTC pin and ground and a resistor ( $R_{\text{HOT}}$ ) from the NTC pin to  $V_{\text{CC}}$ .  $R_{\text{HOT}}$  should be a 1% resistor with a value equal to the value of the chosen NTC thermistor at 50 $^{\circ}\text{C}$  (this value is 4.1k for a Vishay NTHS0603N02N1002J thermistor). The LTC1733 goes into hold mode when the resistance of the NTC thermistor drops below 4.1k which should be at 50 $^{\circ}\text{C}$ . The hold mode freezes the timer and stops the charge cycle until the thermistor indicates a return to a valid temperature. As the temperature drops, the

## APPLICATIONS INFORMATION

resistance of the NTC thermistor rises. The LTC1733 is designed to go into hold mode when the value of the NTC thermistor increases to seven times the value of  $R_{HOT}$ . For a Vishay NTHS0603N02N1002J thermistor, this value is 28.2k which corresponds to approximately 0°C. The hot and cold comparators each have approximately 2°C of hysteresis to prevent oscillation about the trip point. The NTC function can be disabled by grounding the NTC pin.

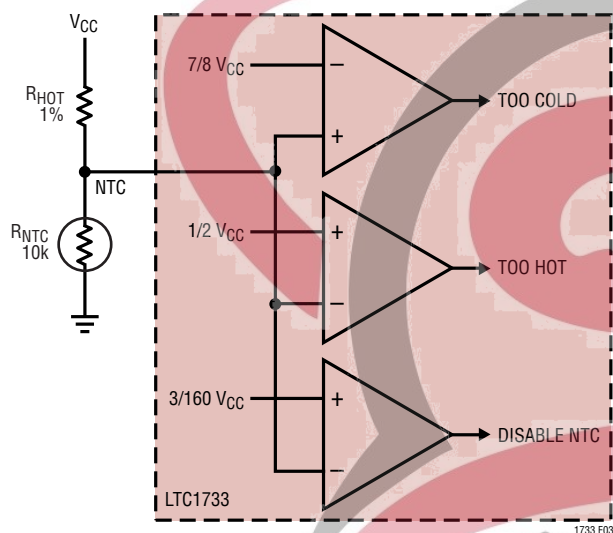

Figure 3.

### Thermistors

The LTC1733 NTC trip points were designed to work with thermistors whose resistance-temperature characteristics follow Vishay Dale's "R-T Curve 2". The Vishay NTHS0603N02N1002J is an example of such a thermistor. However, Vishay Dale has many thermistor products that follow the "R-T Curve 2" characteristic in a variety of sizes. Furthermore, any thermistor whose ratio of  $R_{COLD}$  to  $R_{HOT}$  is about 7.0 will also work (Vishay Dale R-T Curve 2 shows a ratio of  $R_{COLD}$  to  $R_{HOT}$  of  $2.816/0.4086 = 6.9$ ).

### NTC Layout Considerations

It is important that the NTC thermistor not be in close thermal contact with the LTC1733. Because the LTC1733 package can reach temperatures in excess of the 50°C trip point, the NTC function can cause a hysteretic oscillation which turns the charge current on and off according to the

package temperature rather than the battery temperature. This problem can be eliminated by thermally coupling the NTC thermistor to the battery and not to the LTC1733.

Furthermore, it is essential that the  $V_{CC}$  connection to  $R_{HOT}$  is made according to standard Kelvin sense techniques. Since  $V_{CC}$  is a high current path into the LTC1733, it is essential to minimize voltage drops between the  $V_{CC}$  input pin and the top of  $R_{HOT}$ .

### NTC Trip Point Errors

When a 1% resistor is used for  $R_{HOT}$ , the major error in the 50°C trip point is determined by the tolerance of the NTC thermistor. A typical 10k NTC thermistor has a  $\pm 10\%$  tolerance. By looking up the temperature coefficient of the thermistor at 50°C, the tolerance error can be calculated in degrees centigrade. Consider the Vishay NTHS0603N02N1002J thermistor which has a temperature coefficient of  $-3.3\%/^{\circ}\text{C}$  at 50°C. Dividing the tolerance by the temperature coefficient,  $\pm 10\%/(-3.3\%/^{\circ}\text{C}) = \pm 3^{\circ}\text{C}$ , gives the temperature error of the hot trip point.

The cold trip point is a little more complicated because its error depends on the tolerance of the NTC thermistor and the degree to which the ratio of its value at 0°C and its value at 50°C varies from 7 to 1. Therefore, the cold trip point error can be calculated using the tolerance, TOL, the temperature coefficient of the thermistor at 0°C, TC (in  $\%/^{\circ}\text{C}$ ), the value of the thermistor at 0°C,  $R_{COLD}$ , and the value of the thermistor at 50°C,  $R_{HOT}$ . The formula is:

$$\text{Temperature Error } (^{\circ}\text{C}) = \frac{\left( \frac{1 + \text{TOL}}{7} \cdot \frac{R_{COLD}}{R_{HOT}} - 1 \right) \cdot 100}{\text{TC}}$$

For example, the Vishay NTHS0603N02N1002J thermistor with a tolerance of  $\pm 10\%$ , TC of  $-4.5\%/^{\circ}\text{C}$ , and  $R_{COLD}/R_{HOT}$  of 6.89, has a cold trip point error of:

$$\begin{aligned} \text{Temperature Error } (^{\circ}\text{C}) &= \frac{\left( \frac{1 \pm 0.10}{7} \cdot 6.89 - 1 \right) \cdot 100}{-4.5} \\ &= -1.8^{\circ}\text{C}, +2.5^{\circ}\text{C} \end{aligned}$$

## APPLICATIONS INFORMATION

If a thermistor with a tolerance less than  $\pm 10\%$  is used, the trip point errors begin to depend on errors other than thermistor tolerance including the input offset voltage of the internal comparators of the LTC1733 and the effects of internal voltage drops due to high charging currents.

### Constant-Current/Constant-Voltage/ Constant-Temperature

The LTC1733 uses a unique architecture to charge a battery in a constant-current, constant-voltage, constant-temperature fashion. Figure 1 shows a simplified block diagram of the LTC1733. Three of the amplifier feedback loops shown control the constant-current, CA, constant-voltage, VA, and constant-temperature, TA modes. A fourth amplifier feedback loop, MA, is used to increase the output impedance of the current source pair, M1 and M2 (note that M1 is the internal P-channel power MOSFET). It ensures that the drain current of M1 is exactly 1000 times greater than the drain current of M2.

Amplifiers CA, TA, and VA are used in three separate feedback loops to force the charger into constant-current, temperature, or voltage mode, respectively. Diodes, D1, D2, and D3 provide priority to whichever loop is trying to reduce the charging current the most. The outputs of the other two amplifiers saturate low which effectively removes their loops from the system. When in constant-current mode, CA servos the voltage at the PROG pin to be precisely 1.50V (or 0.15V when in trickle-charge mode). TA limits the die temperature to approximately 105°C when in constant-temperature mode and the PROG pin voltage gives an indication of the charge current as discussed in “Programming Charge Current”. VA servos its inverting input to precisely 2.485V when in constant-voltage mode and the internal resistor divider made up of R1 and R2 ensures that the battery voltage is maintained at either 4.1V or 4.2V. Again, the PROG pin voltage gives an indication of the charge current.

In typical operation, the charge cycle begins in constant-current mode with the current delivered to the battery equal to  $1500V/R_{PROG}$ . If the power dissipation of the LTC1733 results in the junction temperature approaching 105°C, the amplifier (TA) will begin decreasing the charge current to limit the die temperature to approximately

105°C. As the battery voltage rises, the LTC1733 either returns to constant-current mode or it enters constant-voltage mode straight from constant-temperature mode. Regardless of mode, the voltage at the PROG pin is proportional to the current being delivered to the battery.

### Power Dissipation

The conditions that cause the LTC1733 to reduce charge current due to the thermal protection feedback can be approximated by considering the power dissipated in the IC. For high charge currents, the LTC1733 power dissipation is approximately:

$$P_D = (V_{CC} - V_{BAT}) \cdot I_{BAT}$$

where  $P_D$  is the power dissipated,  $V_{CC}$  is the input supply voltage,  $V_{BAT}$  is the battery voltage, and  $I_{BAT}$  is the battery charge current. It is not necessary to perform any worst-case power dissipation scenarios because the LTC1733 will automatically reduce the charge current to maintain the die temperature at approximately 105°C. However, the approximate ambient temperature at which the thermal feedback begins to protect the IC is:

$$T_A = 105^\circ\text{C} - P_D \theta_{JA}$$

$$T_A = 105^\circ\text{C} - (V_{CC} - V_{BAT}) \cdot I_{BAT} \cdot \theta_{JA}$$

Example: Consider an LTC1733 operating from a 5V wall adapter providing 1.2A to a 3.75V Li-Ion battery. The ambient temperature above which the LTC1733 will begin to reduce the 1.2A charge current is approximately:

$$T_A = 105^\circ\text{C} - (5V - 3.75V) \cdot 1.2A \cdot 40^\circ\text{C/W}$$

$$T_A = 105^\circ\text{C} - 1.5W \cdot 40^\circ\text{C/W} = 105^\circ\text{C} - 60^\circ\text{C} = 45^\circ\text{C}$$

The LTC1733 can be used above 45°C, but the charge current will be reduced below 1.2A. The approximate charge current at a given ambient temperature can be approximated by:

$$I_{BAT} = \frac{105^\circ\text{C} - T_A}{(V_{CC} - V_{BAT}) \cdot \theta_{JA}}$$

Consider the above example with an ambient temperature of 55°C. The charge current will be reduced to approximately:

## APPLICATIONS INFORMATION

$$I_{\text{BAT}} = \frac{105^{\circ}\text{C} - 55^{\circ}\text{C}}{(5\text{V} - 3.75\text{V}) \cdot 40^{\circ}\text{C} / \text{W}} = \frac{50^{\circ}\text{C}}{50^{\circ}\text{C} / \text{A}} = 1\text{A}$$

Furthermore, the voltage at the PROG pin will change proportionally with the charge current as discussed in the Programming Charge Current section.

It is important to remember that LTC1733 applications do not need to be designed for worst-case thermal conditions since the IC will automatically reduce power dissipation when the junction temperature reaches approximately 105°C. See Design Note 283 for additional information.

### Board Layout Considerations

In order to be able to deliver maximum charge current under all conditions, it is critical that the exposed pad on the backside of the LTC1733 package is soldered to the board. Correctly soldered to a 2500mm<sup>2</sup> double-sided 1oz. copper board the LTC1733 has a thermal resistance of approximately 40°C/W. Failure to make thermal contact between the exposed pad on the backside of the package and the copper board will result in thermal resistances far greater than 40°C/W. As an example, a correctly soldered LTC1733 can deliver over 1250mA to a battery from a 5V supply at room temperature. Without a backside thermal connection, this number could drop to less than 500mA.

### V<sub>CC</sub> Bypass Capacitor

Many types of capacitors can be used for input bypassing. However, caution must be exercised when using multi-layer ceramic capacitors. Because of the self resonant and high Q characteristics of some types of ceramic capacitors, high voltage transients can be generated under some start-up conditions, such as connecting the charger input to a hot power source. For more information refer to Application Note 88.

### Stability

The constant-voltage mode feedback loop is stable without any compensation when a battery is connected. However, a 1μF capacitor with a 1Ω series resistor to GND is recommended at the BAT pin to keep ripple voltage low when the battery is disconnected.

In the constant-current mode it is the PROG pin that is in the feedback loop and not the battery. The constant-current mode stability is affected by the impedance at the PROG pin. With no additional capacitance on the PROG pin, stability is acceptable with program resistor values as high as 50k. However, additional capacitance on this node reduces the maximum allowed program resistor. The pole frequency at the PROG pin should be kept above 500kHz. Therefore, if the PROG pin is loaded with a capacitance, C, the following equation should be used to calculate the maximum resistance value for R<sub>PROG</sub>:

$$R_{\text{PROG}} < 1 / (6.283 \cdot 500\text{E}3 \cdot C)$$

Average, rather than instantaneous, battery current may be of interest to the user. For example, if a switching power supply operating in low-current mode is connected in parallel with the battery the average current being pulled out of the BAT pin is typically of more interest than the instantaneous current pulses. In such a case, a simple RC filter can be used on the PROG pin to measure the average battery current as shown in Figure 4. A 10k resistor is added between the PROG pin and the filter capacitor and monitoring circuitry to ensure stability.

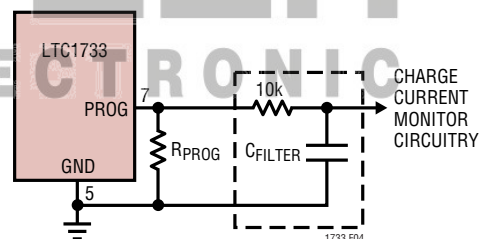
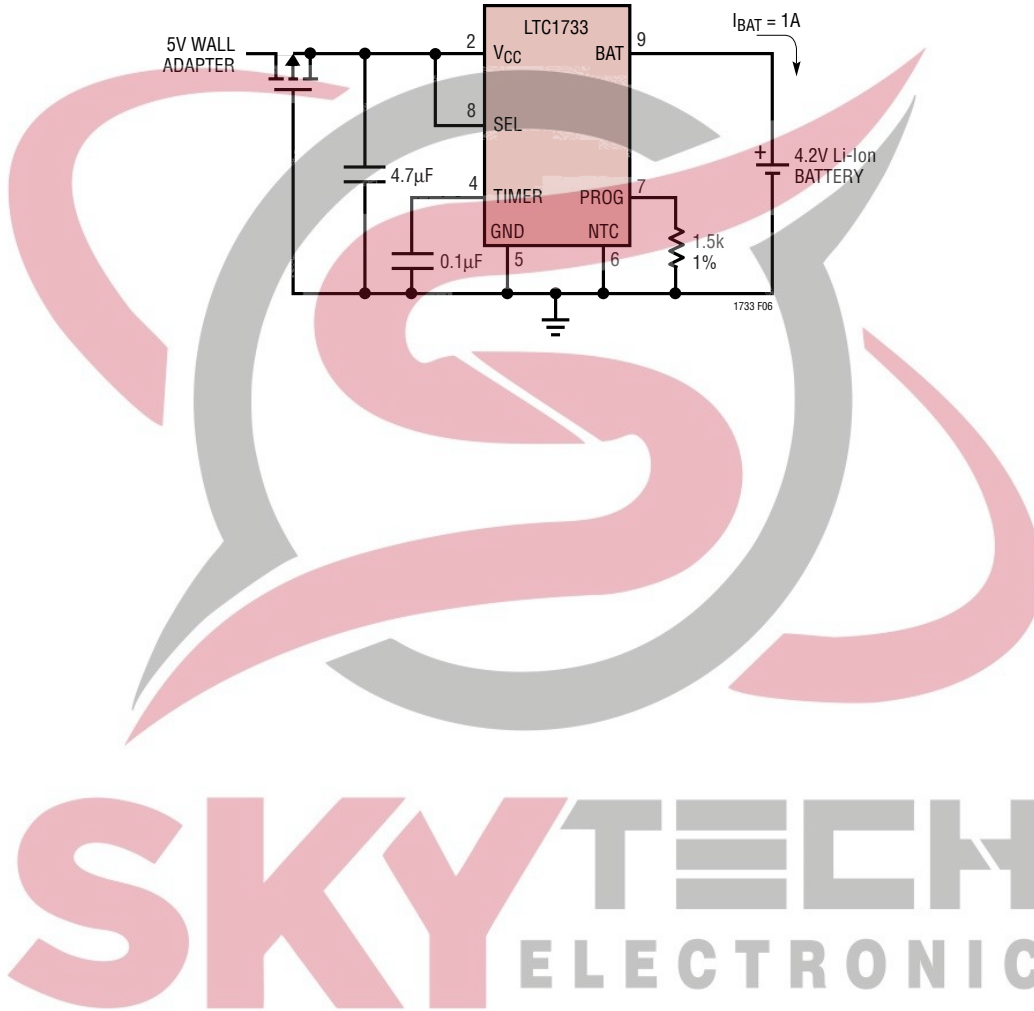

Figure 4. Isolating Capacitive Load on PROG Pin and Filtering.

**TYPICAL APPLICATION**

**Basic Li-Ion Battery Charger with Reverse Polarity Input Protection**



**SKYTECH**  
ELECTRONIC

## PACKAGE DESCRIPTION

**MSE Package**  
**10-Lead Plastic MSOP**  
 (Reference LTC DWG # 05-08-1663)

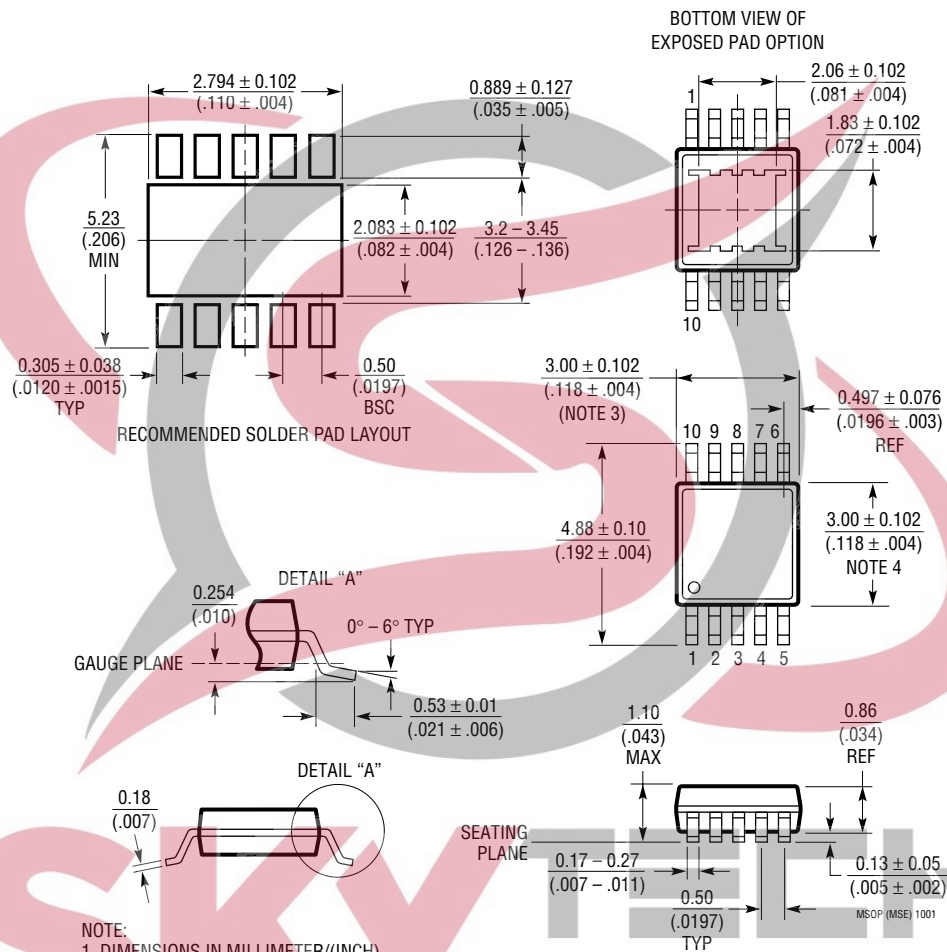

## NOTE:

1. DIMENSIONS IN MILLIMETER/(INCH)
2. DRAWING NOT TO SCALE
3. DIMENSION DOES NOT INCLUDE MOLD FLASH, PROTRUSIONS OR GATE BURRS. MOLD FLASH, PROTRUSIONS OR GATE BURRS SHALL NOT EXCEED 0.152mm (.006") PER SIDE
4. DIMENSION DOES NOT INCLUDE INTERLEAD FLASH OR PROTRUSIONS. INTERLEAD FLASH OR PROTRUSIONS SHALL NOT EXCEED 0.152mm (.006") PER SIDE
5. LEAD COPLANARITY (BOTTOM OF LEADS AFTER FORMING) SHALL BE 0.102mm (.004") MAX

## TYPICAL APPLICATION

Full Featured Single Cell Li-Ion Charger

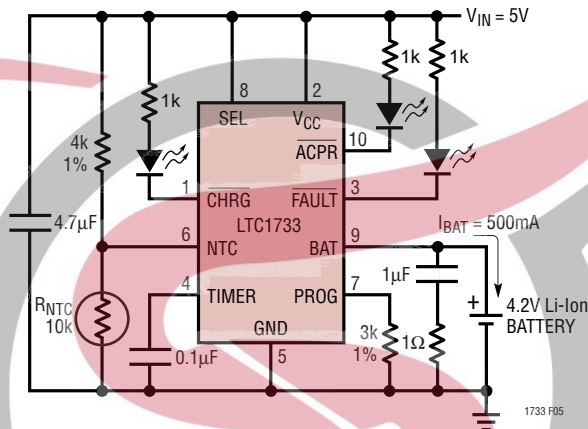

## RELATED PARTS

PART NUMBER	DESCRIPTION	COMMENTS
LT1571	200kHz/500kHz Switching Battery Charger	Up to 1.5A Charge Current; Preset and Adjustable Battery Voltages
LTC1729	Lithium-Ion Battery Charger Termination Controllers	Time or Charge Current Termination, Preconditioning 8-Lead MSOP
LTC1730	Lithium-Ion Battery Pulse Charger	No Blocking Diode Required, Current Limit for Maximum Safety
LTC1731	Lithium-Ion Linear Battery Charger Controller	Simple Charger uses External FET, Features Preset Voltages, C/10 Charger Detection and Programmable Timer
LTC1732	Lithium-Ion Linear Battery Charger Controller	Simple Charger uses External FET, Features Preset Voltages, C/10 Charger Detection and Programmable Timer, Input Power Good Indication
LTC1734	Lithium-Ion Linear Battery Charger in ThinSOT	Simple ThinSOT Charger, No Blocking Diode, No Sense Resistor Needed
LTC1998	Lithium-Ion Low Battery Detector	1% Accurate 2.5µA Quiescent Current, SOT-23
LTC4050	Lithium-Ion Linear Battery Charger Controller	Simple Charger uses External FET, Features Preset Voltages, C/10 Charger Detection and Programmable Timer, Input Power Good Indication, Thermistor Interface